



Video Analyzer UAF

Perfection in video analysis

- Ease of operation
- 3 signal inputs
- 25 video parameters
- Limit monitoring
- Full-field measurements
- Convenient result display
- Freely selectable test signal
- Memory card
- Printer interface
- Remote control (IEC/IEEE bus)
- Small dimensions



ROHDE & SCHWARZ



Brief description

- Rapid
- Precise
- Reliable

Measurement accuracy for satisfying studio quality requirements and measuring times in the seconds range – these are the standards which have to be met in present-day automatic video measurement engineering. Thanks to its outstanding characteristics, Video Analyzer UAF from Rohde & Schwarz fully complies with these requirements. User-friendly operation and a clear display with graphics support ensure straightforward measurements. Moreover, the UAF features state-of-the-art design, great flexibility, compactness and light weight.

Characteristics and use

The signal analysis comprises 25 video and test line parameters and covers all important levels as well as linear and nonlinear distortions such as 2T K rating, frequency response and hum. The position of the test lines can be freely selected over the entire picture area and in the field blanking interval; storage of up to eight test configurations is possible.

Thanks to its variable integration time, the UAF can be adapted to all test conditions. Using the shortest integration time of less than 1 s, the UAF is ideal for all alignments, be it in the studio or in production. In the case of very noisy VTR signals, on long transmission links or at the end of a long line of transposers, increasing the integration time to 2.5, 5 or 10 s always yields stable results.

For measurements in the field, on cable networks or at inaccessible points in transmitters, it is not necessary to bring along a computer or printer to log data. Using a plug-in memory card, customer-defined test and data-logging

programs can be loaded and the test results also stored on the card.

Moreover, the memory card permits storage of complete instrument setups: limit values, test parameter definitions, filter settings in the case of noise voltage measurements as well as line numbers of the eight test configurations. Thus any measurement can be reproduced.

For use in quality and production control of video recorders, the UAF also handles the S-VHS component signals Y/C.

Distorted test signals due to jitter or head switchover for instance do not affect the operation of the UAF.

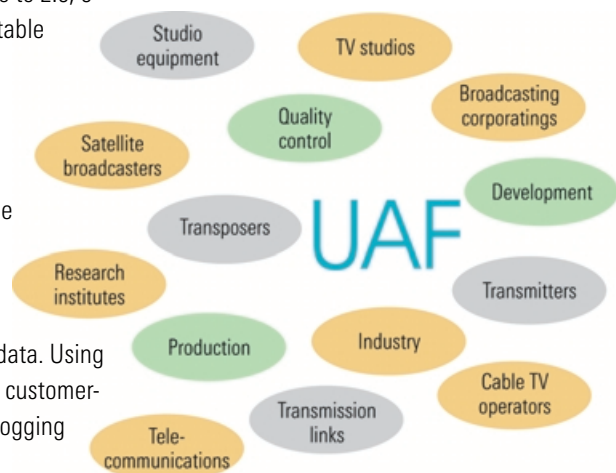

A selection of the manifold applications of the UAF

Operation

The logical arrangement of the UAF front-panel controls offers a clear overview of its functions and ensures ease of operation.

Each parameter is assigned its own key. The associated LED above the key blinks if the limit values are exceeded. Thus all parameters can be checked at a glance for adherence to set limits.

The illuminated LC display shows the result in large figures which are easy to read even from some distance. Several parameters can be displayed at the same time in small characters. For certain applications, eg alignment, the bar indication proves useful.

The complete device setup and the selected limit values are contained in the upper lines of the display. The lower part shows the function of the unlabelled keys. These softkeys offer user prompting with respect to the displayed measured value or the called function.

The small keypad to the left of the display permits the setup menus of the UAF to be selected directly. Such a menu is inserted as a window above the normal result display. So it is possible to use the softkeys for changing general settings such as selected input, synchronization or printer mode.

Further test parameters, eg an external level or future extensions, can be called up using the "option" function.

For integration into computer-controlled test systems, all functions of the UAF can be remote-controlled via an IEC/IEEE-bus interface. The UAF can also be used as the controller. If parameter logging is required for acceptance test measurements, a printer can be connected directly to the Centronics interface.

Mode 1	Mode 2	Mode 3	Mode 4	Mode 5	Mode 6	Mode 7	Mode 8
Test signal eg CCIR 17, 10T pulse/20T pulse				Parameter definitions eg S/N, weighting filter on/off			
Test line eg CCIR 17 in line 19							
Limit values eg BAR Set 1: +10% / -15% Set 2: +15% / -20% Hysteresis: 3%							

For rapid recall, for instance within a test routine, the UAF is able to store up to 8 test configurations (modes 1 to 8)

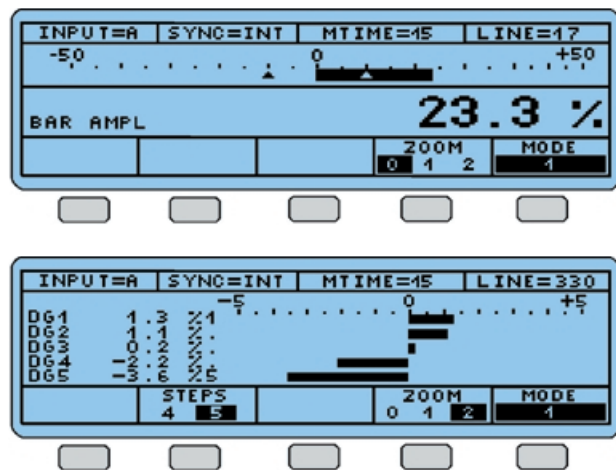

The test results are displayed either in the form of numerical values or as bars

Special modes

Difference measurement

This mode permits signal errors at the input of the device under test (DUT) to be eliminated. For this purpose the input signal of the DUT is applied to channel A and the output signal to channel B of the UAF. In this way it is possible to perform measurements on a transposer system or a cable headend receiving incorrect input signals.

Thanks to the high display accuracy of the UAF, the difference measurement mode is also suitable for high-precision studio measurements on components such as routing switchers which feature stringent tolerances.

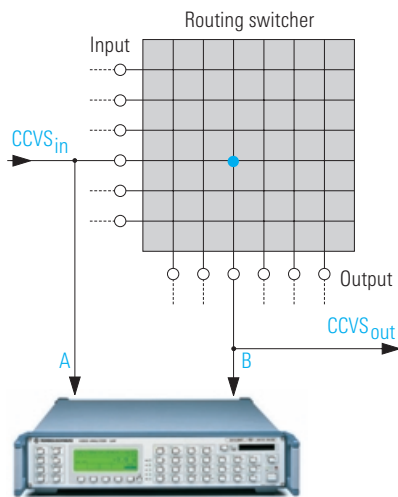

Difference measurement

Reference measurement

In this mode only one input of the UAF is connected to the DUT, the first test cycle being stored as the reference. This mode facilitates determination of the effect of the environment (EMC, climate, etc) on video generators in the lab and in servicing.

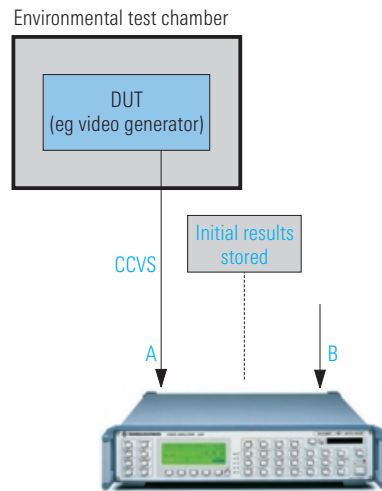

Reference measurement

Automatic test sequence

The AUTORUN menu allows test sequences to be programmed on the UAF front panel; these sequences are executed automatically and can be repeated cyclically using the built-in realtime clock. An AUTORUN routine may for instance ensure input switchover, mode variation, limit monitoring and result logging.

Since the UAF is able to act as a controller for other instruments, its controller functions can be included in an AUTORUN routine. Thus it is for instance possible to send commands to the IEC/IEEE-bus-compatible TV Test Receiver EMFT (data sheet PD 756.4843) in order to set the receive channel. Without the use of a controller, the UAF and EMFT are able to set all channels of a cable network, monitor the signal quality and print error logs in the AUTORUN mode. This capability can even be extended when using the Video Selector VSF.

Description and technology

The combination of analog signal conditioning and digital result processing is the basis of the powerful performance of the UAF and all this in spite of its small size.

In the analog section, the video signal is processed in parallel by different precision test circuits for chrominance and luminance measurements. An A/D converter digitizes both the test circuit output voltages and parts of the video signal directly. Its 12-bit resolution together with the precise analog circuitry ensure the unique measurement accuracy of the UAF.

The core of the digital section is a micro-processor plus an arithmetic coprocessor. It rapidly calculates the results from the samples averaging them over the integration time. The computing power is such that all test parameters are constantly calculated, updated and monitored without leaving out any samples. In addition, the keypads, interfaces and the memory card are serviced.

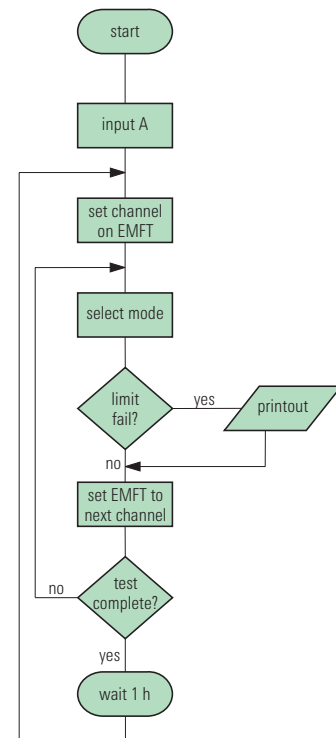

Example of AUTORUN routine



Rear panel of UAF

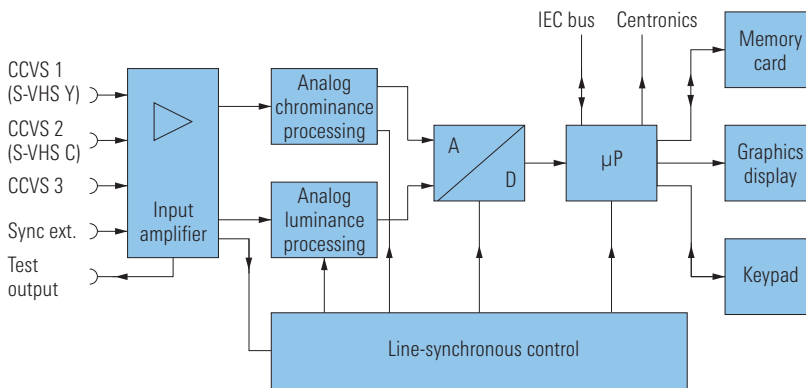

















Block diagram of UAF

Certified Quality System
ISO 9001
 DQS REG. NO 1954

Certified Environmental System
ISO 14001
 REG. NO 1954

Specifications

Test parameter		Key label	Measurement range	Resolution	Error limits ¹⁾ at nominal	Additional max. error per 1% (1°, 1 ns) departure from nominal
Luminance bar amplitude		BAR AMPL	-100% to +100%	0.1%	±0.3%	0.015%
Black level distortion		BASELINE DIST	-20% to +40%	0.1%	±0.3%	0.045%
Tilt of luminance bar		TILT	-40% to +40%	0.1%	±0.3%	0.045%
2T pulse amplitude		2T AMPL	-50% to +50%	0.1%	±0.5%	0.03%
2T K factor		2T K FACTOR	0% to +10%	0.1%	±0.7%	0.03%
Luminance nonlinearity		LUM NL	0% to +50%	0.1%	±0.5%	0.01%
Residual picture carrier		RES PC	0% to +30%	0.1%	±0.3%	0.015%
Sync pulse amplitude		SYNC AMPL	-50% to +50%	0.1%	±0.5%	0.01%
Reference = signal			-80% to +100%	0.1%	±0.5%	0.01%

Test parameter		Key label	Measurement range	Resolution	Error limits ¹⁾ at nominal	Additional max. error per 1% (1°, 1 ns) departure from nominal
Colour subcarrier gain CCIR 331		C/L GAIN	-50% to +50%	0.1%	±1.0%	0.02%
CCIR 17			-50% to +50%	0.1%	±1.0%	0.02%
Chrominance / luminance intermodulation CCIR 331		C/L INTERMOD	-50% to +50%	0.1	±0.3%	0.01%
CCIR 17			-50% to +50%	0.1%	±1.0%	0.02%
Chrominance / luminance delay		C/L DELAY	-500 ns to +500 ns	1 ns	±5 ns	0.01 ns
Differential gain positive / negative peak-to-peak		DIFF GAIN	-50% to +50% 0% to +100%	0.1% / 0.01% ²⁾ 0.1% / 0.01% ²⁾	±0.3% ±0.5%	0.025% 0.015%
Differential phase positive / negative peak-to-peak		DIFF PHASE	-50° to +50° 0° to +100°	0.1° / 0.01° ²⁾ 0.1° / 0.01° ²⁾	±0.3° ±0.5°	0.025° 0.015°
Nonlinearity of colour subcarrier gain positive / negative peak-to-peak		C NL GAIN	-50% to +50% 0% to +100%	0.1% 0.1%	±0.7% ±1.0%	0.025% 0.02%
Nonlinearity of colour subcarrier phase positive / negative peak-to-peak		C NL PHASE	-50° to +50° 0° to +100°	0.1° 0.1°	±0.7° ±1.0°	0.025° 0.02°
Burst amplitude Reference = signal Reference = nominal		BURST AMPL	-50% to +50% -80% to +80%	0.1° 0.1°	±1.0% ±1.0%	0.02% 0.02%
Multiburst amplitude		MULTIB 1 to 6	-80% to +50%	0.1%	±1.0%	0.02%
Luminance signal/noise ratio		S/N	25 dB to 80 dB	0.1 dB	±1 dB	—
Intermodulation between colour subcarrier and sound carrier		C/SND INTERMOD	30 dB to 70 dB	0.1 dB	±1 dB	—
Hum		HUM	6 dB to 60 dB	0.1 dB	±1 dB	—
DC measurement			-5 V to +5 V	5 mV	±10 mV	—
Basic amplitude of video data			-50% to +50%	0.1%	±1%	0.01%
Incidental carrier phase modulation			-7° to +45°	0.1°	±1°	0.01°

¹⁾ With difference and reference measurement modes, attainable error limits are ±2 digits for all parameters.

²⁾ Higher resolution for difference and reference measurements.

Signal inputs	3 video inputs, 75 Ω loopthrough filters, 3 x CCVS or 1 x Y/C and 1 x CCVS, adjustable
Level	1 V pp \pm 6 dB
Return loss up to 10 MHz	\geq 40 dB
Decoupling of inputs up to 10 MHz	\geq 85 dB

Synchronization

Internal	optionally from one of the three inputs, sync pulse level 300 mV \pm 6 dB
External	1 input, loopthrough filter, nominal level 2 V/4 V into 75 Ω (V pp) permissible
SIS	permissible
Parameters	25 test parameters, direct key selection

Noise voltage	
Measurement mode	rms
Filter	200 kHz highpass and video filter integrated, weighting filter and colour sub-carrier trap can be connected
Inherent S/N ratio	$>$ 83 dB
Reference	luminance bar or 700 mV nominal, selectable
Differential gain/phase	
Evaluation	4 or 5 steps (selectable)
Hum	
Measurement mode	peak-to-peak
Filter	1 kHz lowpass integrated
Reference	luminance bar or 700 mV nominal, selectable

Special functions

SETUP	setting of test signal, test lines, ON state, display mode, limit values, IEC/IEEE-bus address, printer type, date and time
MEAS TIME	measuring time 1/2.5/5/10 s, selectable
MEAS HOLD	measured values of all parameters are simultaneously frozen
PRINT	measured value output via printer (Centronics interface)
MONITORING	limit monitoring of single parameters, parameter groups or all parameters; two upper and two lower parameter limits freely adjustable for every mode
Limit monitoring	out-of-limit indication by blinking of associated LED, acoustic alarm can be switched on, error logging
AUTORUN	entry and recall of user-defined test routine
Difference measurement	selectable between two inputs (measuring time doubled)
Reference measurement	one test cycle stored as reference

Indication

LC display, display mode selectable	numerical, 1 parameter numerical, 3 parameters numerical with bar display
Types of indication	measured value, limit values, major modes, prompting
Language	German, English, French or Italian

Interfaces and outputs

IEC/IEEE bus	interface to IEC 625-2/IEEE 488-2
Printer	Centronics interface
Memory card	storage of measured values, limit values and parameter definitions, device set-ups and user-defined test routines
Monitor output	clamped test signal, also for display of measurement timing, level same as input signal \pm 1%, 75 Ω
Zero reference control	2.5 V pp \pm 10% into 75 Ω , position and duration adjustable

General data

Rated temperature range	+5 $^{\circ}$ C to +45 $^{\circ}$ C (application class I to IEC 359)
Power supply	100/120/220/240 V \pm 10%, 47 Hz to 63 Hz, 115 VA, safety class 1
Dimensions (W x H x D)	435 mm x 103 mm x 460 mm
Weight	10 kg

Ordering information

Video Analyzer UAF

Standard B/G	2013.0807.02
Standard I	2028.5768.05
Standard M	2028.5774.02
Standard D/K	2028.5780.02

Accessories supplied

Power cord
Spare fuses
Manual
Four 75 Ω Terminations RMF 2
Memory card 32 Kbyte

Options

Documentation of calibration values	UAF-DCV	2082.0490.02
-------------------------------------	---------	--------------



ROHDE & SCHWARZ

ROHDE & SCHWARZ GmbH & Co. KG · Muehldorfstrasse 15 · 81671 Munich, Germany · P.O.B. 80 14 69 · 81614 Munich, Germany

Telephone +4989 4129-0 · www.rohde-schwarz.com · CustomerSupport: Tel. +491805124242, Fax +4989 4129-13777, E-mail: CustomerSupport@rohde-schwarz.com